



**KONTI**  
**HIDROPLAST**®

PRODUCTION OF POLYETHYLENE  
AND POLYPROPYLENE PIPES

A large, dynamic splash of clear blue water with many bubbles, filling the right and bottom portions of the page. On the left side, there is a large, stylized graphic of a pipe section, represented by two concentric dark blue arcs with white borders, curving from the top left towards the bottom left.

**PE 100 RC**  
**SINGLE AND**  
**MULTILAYER PIPE**

[www.konti-hidroplast.com.mk](http://www.konti-hidroplast.com.mk)



# CONTENTS

INTRODUCTION .....	2
PRODUCT DESCRIPTION .....	5
STANDARDS .....	6
ADVANTAGES OF PE 100 RC MULTILAYER PIPES .....	7
PRODUCT DATA SHEETS .....	9
CERTIFICATES .....	10
SELECTION OF PIPE MATERIAL .....	11
PROTECTIVE LAYER – ACTIVE PROTECTION .....	12
PE 100 RC MULTILAYER WATER PIPE .....	13
PE 100 RC MULTILAYER GAS PIPE .....	15
PE 100 RC + PP ADDITIONAL LAYER MULTILAYER WATER PIPE .....	17
OPTIONAL MULTILAYER SEWAGE PIPE .....	19
MARKING A PIPE .....	19
BARCODE LASER MARKING .....	20
PACKAGING .....	21
INSTALATION .....	21
METHODS OF CONNECTING .....	21
BUTT WELDING .....	21
CONNECTION METHOD CONNETION METHOD FOR TYPE 3 PIPE .....	25
CERTIFICATIONS .....	26
LAYING INSTRUCTIONS .....	31
FITTINGS .....	31
CERTIFICATES .....	32
LABORATORY TESTING .....	33



# *KONTI HIDROPLAST*®

## WELCOME TO OUR WORLD

Konti Hidroplast is part of the world's largest manufacturer and supplier of high performance plastic pipes and offers the best and the most cost effective pipe systems for its customers.

Konti Hidroplast specialises in polyethylene pipe systems for gas and water transportation in the utilities and industrial markets.

### MARKET ORIENTED

Konti Hidroplast products find a broad range of applications in the industrial and utilities market on a worldwide scale.

The water and gas distribution enterprises are important sectors for high integrity products where the maintenance of water quality and the safe transport of gaseous fuels are of paramount importance.

Industrial applications include alternative energy installations in landfill gas systems to effluent transportation and mineral slurry.

Products are widely used in pipeline installation, repair and maintenance.

Many of the brands in the Konti Hidroplast portfolio have a long record of innovation in meeting the needs of the water and gas utilities.

Being one of the foremost pioneers in polyethylene pipe systems, Konti Hidroplast is continually improving and updating its offer to meet the ever growing needs of the distribution engineer; ensuring they stay at the forefront of world gas and water distribution/treatment systems.





## CUSTOMER FOCUS

The key to our success lies in the commitment to provide the highest quality service and support. We are a team of highly motivated and experienced individuals.

We place the utmost importance on meeting the needs of our customers, constantly evolving our extensive product portfolio to meet the ever changing demands of the water and gas utilities, industrial and foreign markets.

## QUALITY

Konti Hidroplast is a result-driven business – its people, products and service. Designed, manufactured and supplied under EN ISO 9001:2000 accredited Quality Management Systems, Konti Hidroplast products comply with relevant national, European and international product standards to ensure complete reliability for our customers.

Besides the ISO certificates for Quality Management Systems and ecology, the gas pipes are also certified by DVGW CERT GmbH.

## THE ENVIRONMENT

Committed to sustainable manufacture and systems, Konti Hidroplast operates and maintains an environmental policy fully accredited by ISO 14001.

## PRODUCT DESCRIPTION

### HIGH QUALITY MATERIAL FOR COST EFFECTIVE INSTALLATION

#### PRODUCT DESCRIPTION

Cost and time pressure forces providers to rethink the conventional methods and use modern materials. For example, the previously required embedding of PE pipes in sand or fine gravel is no longer necessary using pipes made of the latest PE 100-RC materials.

Conventional pipelines made of PE are exposed to higher stresses caused by stones, refuse glass and other compact materials present in the ground when no sand bedding is provided. In combination with the operating stresses (internal pressure, traffic and soil loads), the punctual or linear forces acting directly upon the pipe will result in stress cracks (slow crack growth PE 100 RC multilayer pipes are co-extruded full-wall pipes with a dimensionally integrated coloured outer layer (drinking water = blue, gas = orange-yellow, waste water = brown). PE 100 RC multilayer is particularly resistant to the consequences following from scratches caused when no sand bedding is provided and to point loads occurring over a longer period of time.

The targeted utilisation of further developed product characteristics – resistance to slow crack growth – ensures the fulfillment of all requirements of modern and economic pipe laying. The manufacturing process ensures a service life of more than 100 years even with unconventional pipe laying (without sand bedding).

### COMPARISON OF PE 100 TO PE 100-RC

All characteristics of the raw material PE 100 proven over many years are also fulfilled by PE 100-RC, e.g. MRS 10. The only, but significant difference is the outstanding resistance of PE 100-RC to stress cracking. Processing, particularly the joining technique, is subject to the same conditions. Welding (e.g. heating element butt welding) is governed by guideline DVS 2207-1 for PE 100-RC as well and preferably without any restrictions.



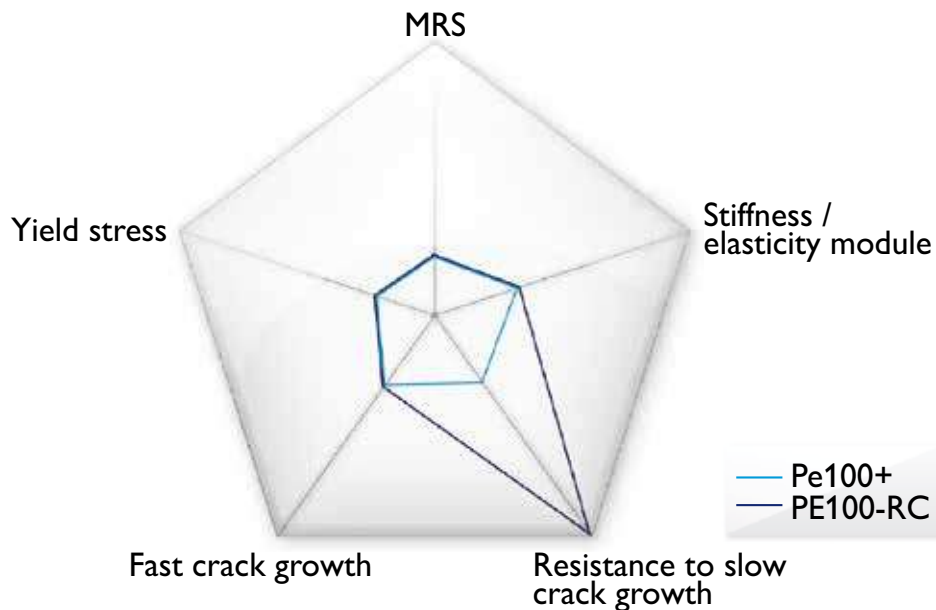

Comparison PE 100 and PE 100-RC

The growing demand for faster and more economic pipe installation with less environmental disturbance has led to new installation techniques. During the last several years, there have been investors in the infrastructure system construction industry searching for solutions for reducing investment costs with advanced technologies. The phenomenon encompasses both new pipelines and the renovation of current ones.

These include sandless bedding, pipe bursting and horizontal directional drilling. In order to apply such methods of pipe-laying and because of their aggressive impact on the pipe, these new methods need new plastic pipe materials – a product that has its external surface durability several times higher than normal and a higher point load resistance.

## STANDARDS

### PAS 1075

In terms of a common definition of the material PE 100-RC the PAS 1075 (Publicly Available Specification) titled “Pipes made of polyethylene for alternative installation technologies” was published by DIN. This publicly available specification is considered a supplement to the existing standards and regulations.

The scope of PAS 1075 is the increased resistance to slow crack growth of PE 100-RC pipes which are used for alternative installation technologies, such as horizontal directional drilling, burst-lining or installation without sand embedding. The requirements, characteristics and test procedures, as well as the respective quality assurance procedures are regulated and ensured via third party inspection. Polyethylene pipes, which are described in the regulation, do have a significantly higher resistance to slow crack growth, compared to the regular PE 80 and PE 100 pipes.



## MATERIAL REQUIREMENTS FOR PE 100 RC

NR.	PROPERTY	STANDARD	REQUIREMENTS
1.	MRS (THE MINIMUM REQUIRED STRENGTH) AT 20 CAND 50 YEARS LIFETIME	EN ISO 9080:2013 10 MPA	DESIGN STRESS, $\sigma = 8.0 \text{ N/mm}^2$
2.	DENSITY	ISO 1183R	$\leq 930 \text{ gr/cm}^3$
3.	MFI	ISO 1133, CONDITION T/ 190/5 KG	02-1.4 gr/10 min
4.	TENSILE STRENGTH AT YIELD	ISO 6259	$e \leq 5 \text{ mm} / 100 \text{ mm/min}$ $5 \text{ mm} < e \leq 12 \text{ mm} / 50 \text{ mm/min}$
5.	THERMAL STABILITY	EN 728/OR ISO 11357	
6.	CARBON BLACK	ISO 6964	2.25% +0.25
7.	DISPERSION OF CARBON BLACK	ISO 18553	$\leq \text{GRADE 3}$

## ADDITIONAL MATERIAL REQUIREMENTS ACCORDING TO PAS 1075

NR.	PROPERTY	REQUIREMENTS
1.	FNTC	> 8760H AT 80 °C, 4N/mm <sup>2</sup> , 2% ARKOPAL N-100 (RAW MATERIAL)
2.	POINT LOAD TEST AT SOLID WALL PIPES	> 8760H AT 80 °C, 4N/mm <sup>2</sup> , 2% ARKOPAL N-100
3.	NOTCH TEST (EN 13479)	>8760H

## ADVANTAGES OF PE 100 RC MULTILAYER PIPES

PE 100 RC class materials and the most advanced plastic processing ensure the highest reliability of the product.

- Good abrasion resistance
- High stress crack resistance
- Good resistance to point loads (e. g. stones, fragments) (Dr. Hessel's test)
- High resistance to slow crack growth
- Optimal choice for pipe-laying without sand embedding and backfill
- Excavated soil can be used as backfill material
- They can be used for pipe-laying without trenches
- They can be butt-welded, ERW, poly fusion welded or connected mechanically
- Compatible with classic PE pipes

## PIPE TRACING

Insertion of INOX or COPPER wire inbetween the first two layers provides easy tracing with metal detector after installation. This is easy, cost effective way to avoid pipe damage during excavations for other purposes.

## PROTECTION AGAINST OCCURRING POINT LOADS WHEN NO SAND BEDDING IS PROVIDED

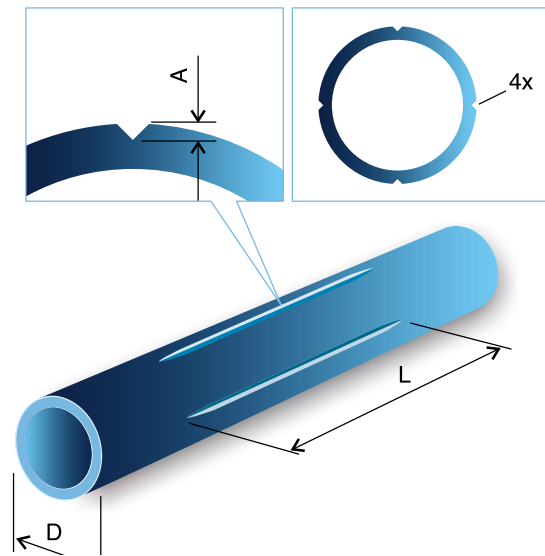

Moulded plate in order to test its resistance to environmental conditions. The sample is notched and then stretched in an Arcopal solution at a specific temperature. The RC material sample should withstand these conditions for 3,300 hours without exhibiting damage (acc. to ISO 16770) (the PE 100 RC multilayer pipe withstands >8 760 h).

The notch test according to PN EN ISO 13479 is a pressure test conducted on a section of a pipe that has been notched on the surface, and then submerged in water at a given temperature and put under hydrostatic pressure. The notch test allows to determine the resistance of pipes to the fast propagation of cracks. The PE 100 RC pipe should withstand the hydrostatic pressure given for 5 000 hours. (PE 100 RC Multilayer® 10 000 h).

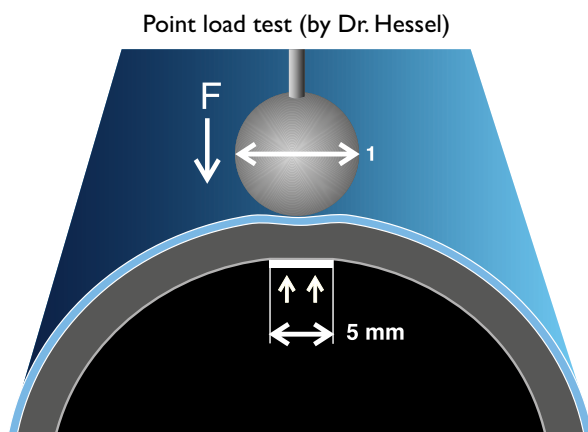
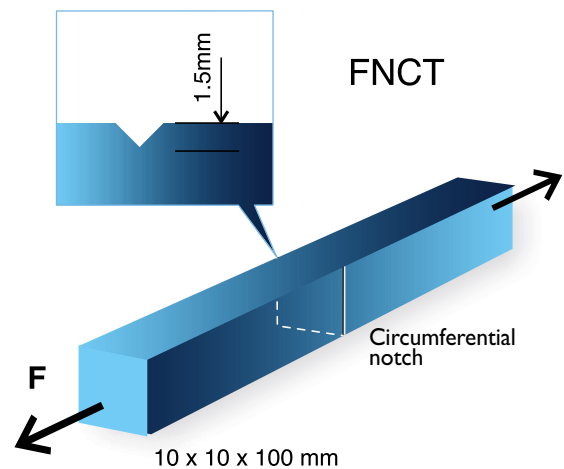

Dr. Hessel's point load test is used to determine a material's resistance to slow propagation of cracks. A sample of pipe section is subjected to external point pressure in a given timeframe and at a specific temperature. The RC sample should withstand these conditions for 8,760 hours without exhibiting damage (PE 100 RC multilayer = 10 000 h).

- Point load test: required result met, test interrupted after 10,000 hours.
- FNCT: required result met.
- Notch test: required result met, test interrupted after 10,000 hours.

## PRODUCT DATA SHEETS

### CLASSIFICATION OF PE 100-RC PIPE

There are several combinations of materials for pipe production, and for PE 100-RC material this combination surpasses the minimal requirements applied with PE 100.

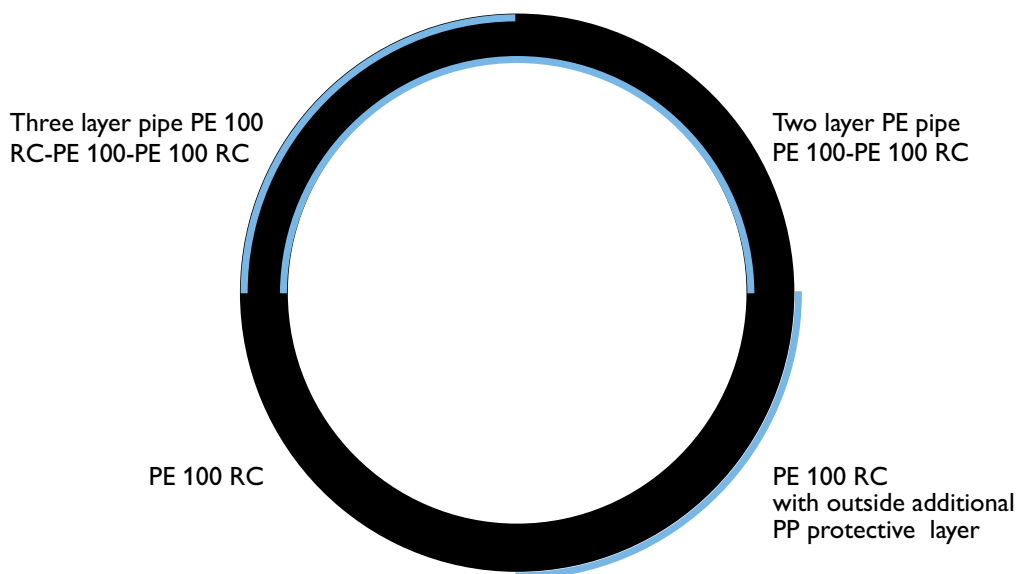

#### TYPE 1: FULL WALL PIPES MADE OF PE 100-RC

Single-layer, full-wall pipes made of PE 100-RC as defined in ISO 4065.

These pipes can be made in colour; blue for water, orange for gas, brown for sewage, black, striped pipe according to the application. They exceed the minimum requirements applicable for PE 100.

#### TYPE 2: PIPE WITH DIMENSIONALLY INTEGRATED PROTECTIVE LAYER MADE OF PE 100-RC

##### DOUBLE LAYER

Double-layer pipes with dimensionally integrated protective layers consist of PE 100 or PE 100-RC and have an internal co-extruded protective layer made of PE 100-RC.

##### TRIPLE LAYER

Triple-layer pipes with dimensionally integrated protective layers consist of PE 100 or PE 100-RC and have an internal and external co-extruded protective layer made of PE 100-RC. The co-extruded layers have been inseparably bonded with each other in a special tool that fuses the layers together. Made of PE 100-RC, the internal layer is integrated as a functional layer in the wall structure.

The layering gauge is to be at least 2.5 mm and possesses protective properties against the formation of stress cracking.

This production is based on two and three-layer pipes which can be with black outside colour with coloured identification stripe or with different external layer colours – blue for water, orange for gas or brown for sewage.

The inside layer is always PE 100 RC, in black or blue color. The other two layers can be PE 100 or PE 100 RC, or combination of both, depending on the specific request of the customers.

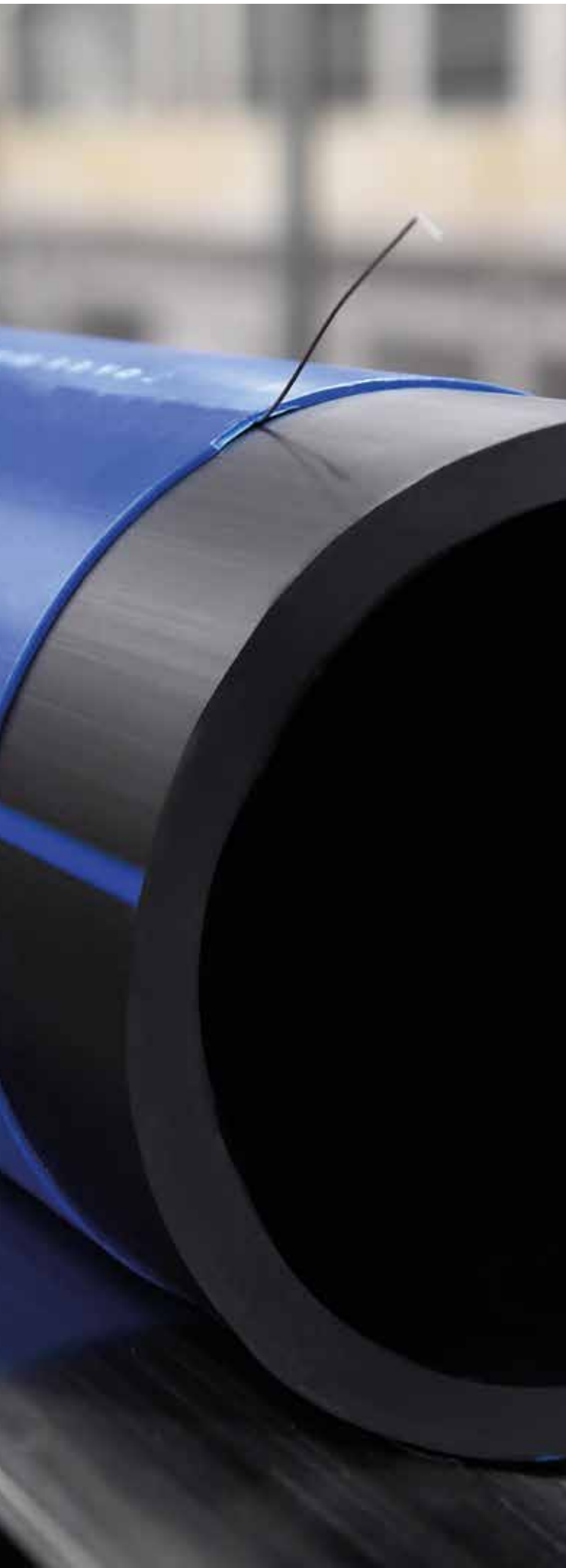

**TYPE 3:** PIPES WITH DIMENSIONS ACCORDING TO ISO 4065 WITH DIMENSIONALLY ADDED OUTER PROTECTIVE LAYER MADE OF PP

Pipes of dimensions as specified in ISO 4065 with outer protective jacket consist of a core pipe made of PE 100-RC /PE 100 monolayer or multilayer pipe, and a protective jacket made of polypropylene. The minimum thickness of the protective jacket is 0.8 mm. The minimum thickness of the protective jacket is dependent on the pipe dimension; large-sized pipes have a thicker jacket because of the heavier loads the pipes are designed for. The bonding strength between the protective jacket and the core pipe must be such that the shearing forces occurring during pipe laying



## CERTIFICATES

PE 100 RC MULTILAYER PIPE water pipes have the same reference documents as the classic PE 100 water pressure pipes. The pipes also have the National Institute of Hygiene certificate.

The PE 100 RC MULTILAYER PIPE gas pipes have the same reference documents as the classic PE 100 gas pipes.

## PE 100-RC MULTILAYER PIPE – PRODUCTION PROGRAM

- PE 100 RC MULTILAYER WATER PIPE
- PE 100 RC MULTILAYER GAS PIPE
- PE 100 RC /PE 100 MULTILAYER MULTIPURPOSE PIPE WITH ADDITIONAL PP LAYER

## SELECTION OF PIPE MATERIAL

The selected installation method is decisive for the choice of material and consequently the risk of damage to the pipe system deployed.

Pipes with dimensionally integrated protective layers in accordance with EN 12201-2/ISO 4065 made of PE 100 RC to PS 1075 types 1 and 2.

Type 1 and Type 2, co-extruded multilayer pipe made of special PE 100 RC. Permanent quality tests reveal high resistance to point loads and related slow crack growth. Predestined for economical sand bed free laying. For service life of >100 years. This pipe construction does not have a notch protection.

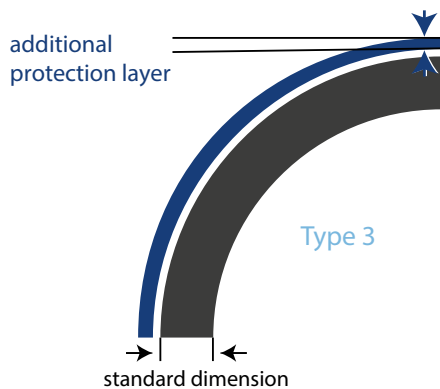
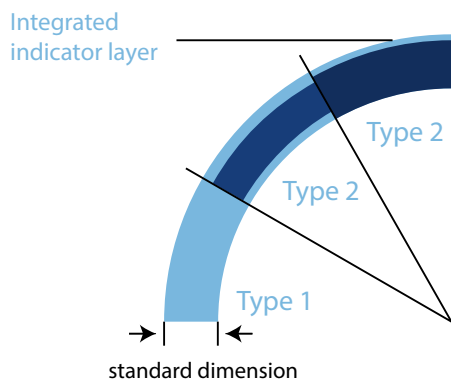

Pipes with dimensionally integrated protective layers

Pipes with dimensions in accordance with EN 12201-2/ISO 4065 made of PE 100-RC monolayer or PE 100RC/PE 100 multilayer; to Pas 1075 Type 3, with additional protective layer with modified PP material. Pressure containing medium pipe effectively excludes mechanical damage.

This pipe is predestinated for all trenchless laying techniques and absolutely necessary for trenchless laying. For a safe service life >100 years. Pipe with protective layer corresponding to Pas 1075 Type 3.

## PROTECTIVE LAYER – ACTIVE PROTECTION

Considerable underground engineering work is involved when creating underground infrastructures. It is therefore the objective of an operator to be able to operate new pipeline for as long as possible without damage. When correctly installed, pipes made from polyethylene offer a service life of at least 100 years. If by contrast they are damaged during installation, this long service life may be substantially curtailed.

Scratches and scoring weaken the pipe wall. This risk can appear during pipe jacketing. Since the standardized wall thickness is precisely attuned to the operating pressure, albeit supplemented by the safety factor, every weakening means a reduction in the engineered safety factor, even a direct reduction in pressure resistance of the new pipeline and consequently in curtailment of the service life.

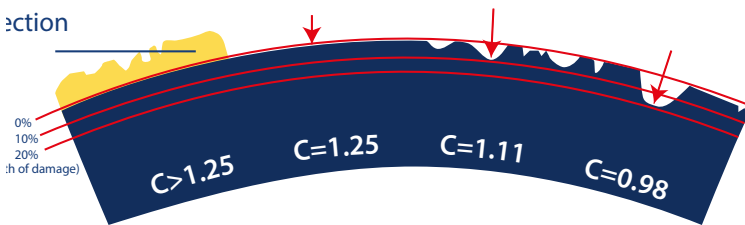

Consideration of the safety factor C in relation to score depth

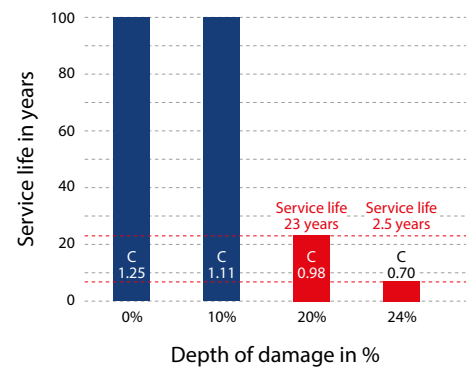

Diagram of service life in relation to damage depth

A damage depth of 10% of the wall thickness is permitted by the codes of practice, because despite the reduction in the safety factor, a curtailment of the service life of the pipeline is not to be expected. By contrast, wreaking of the pipe wall that penetrates deeper than this is dangerous.

With an analysis of these damages, the safety factor drops to below 1, starting from a damage of the pipe wall of 20% due to reduction of wall thickness.



## PE 100 RC MULTILAYER WATER PIPE

### PIPE TYPE 1

<b>PIPE DESIGN</b>	BLACK PIPE WITH BLUE COLOURED STRIPE OR 100% BLUE
<b>APPLICATION</b>	DRINKING WATER FOR BURIED INSTALLATION, LAYING POSSIBLE WITH AND WITHOUT SAND BEDDING
<b>PRODUCT STANDARD</b>	EN 12201-2:2011, DIN 8074:2011-12, DIN 8075:2011-12, PAS 1075:2009-03-TYPE 1
<b>PROCESSING STANDARD</b>	EN 805, DIN V ENV 1046
<b>MATERIAL</b>	PE 100 RC
<b>APPROVALS</b>	DVGW, TZW, MPA CERT
<b>CERTIFICATION</b>	ISO 9001/ISO 14001
<b>DIMENSIONS</b>	SDR 17; SDR11; SDR9; SDR7.4; SDR6
<b>DELIVERY FORM</b>	AVAILABLE UP TO 125mm IN COILS, DIMENSIONS FROM 140mm AND ABOVE IN STRAIGHT LENGTH

### PIPE TYPE 2

<b>PIPE DESIGN</b>	DOUBLE LAYERED – OUTSIDE BLACK (OR BLUE) PE 100 OR PE 100 RC WITH INSIDE LAYER PE100 RC (MIN 2.5 MM OR 8% ) IN BLUE (OR BLACK) COLOUR. IF THE OUTSIDE IS BLACK, THEN IT HAS A BLUE STRIPE FOR DRINKING WATER IDENTIFICATION.  TRIPLE LAYER PIPE – OUTSIDE AND INSIDE IN BLUE OR BLACK, PE 100 RC (LAYER THICKNESS MIN 2.5 MM OR 8%) AND MIDDLE PE 100 MATERIAL IN BLACK OR BLUE COLOUR.
<b>APPLICATION</b>	DRINKING WATER FOR BURIED INSTALLATION, LAYING POSSIBLE WITH AND WITHOUT SAND BEDDING
<b>PRODUCT STANDARD</b>	EN 12201-2:2011, DIN 8074:2011-12, DIN 8075:2011-12, PAS 1075:2009-03-TYPE 2
<b>PROCESSING STANDARD</b>	EN 805, DIN V ENV 1046
<b>MATERIAL</b>	PE 100 RC, PE 100
<b>APPROVALS</b>	DVGW, TZW, MPA CERT
<b>CERTIFICATION</b>	ISO 9001/ISO 14001
<b>DIMENSIONS</b>	SDR 17; SDR11; SDR9; SDR7.4; SDR6
<b>DELIVERY FORM</b>	AVAILABLE UP TO 125mm IN COILS, DIMENSIONS FROM 140mm AND ABOVE IN STRAIGHT LENGTH

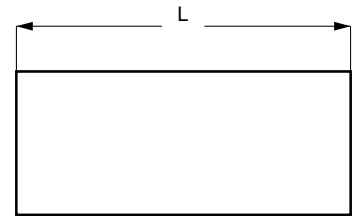
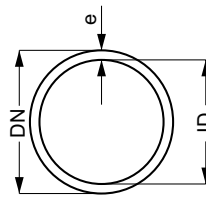
**TABLE OF PIPE DIMENSIONS**
**PE 100 RC MULTILAYER PIPE**

DN/ OD (mm)	SDR 17 S 8 *PN 10		SDR 11 S 5 *PN 16		SDR 9 S 4 *PN 20		SDR 7.4 S 4 *PN 25		SDR 6 S 2.5 *PN 32	
	s (mm)	WEIGHT (kg/m)	s (mm)	WEIGHT (kg/m)	s (mm)	WEIGHT (kg/m)	s (mm)	WEIGHT (kg/m)	s (mm)	WEIGHT (kg/m)
20	-	-	2.0	0.115	2.3	0.133	3.0	0.16	3.4	0.18
25	2.0	0.137	2.3	0.171	3.0	0.200	3.5	0.240	4.2	0.278
32	2.0	0.187	3.0	0.272	3.6	0.327	4.4	0.386	5.4	0.454
40	2.4	0.295	3.7	0.430	4.5	0.509	5.5	0.600	6.7	0.701
50	3.0	0.453	4.6	0.666	5.6	0.788	6.9	0.936	8.3	1.09
63	3.8	0.721	5.8	1.05	7.1	1.26	8.6	1.47	10.5	1.73
75	4.5	1.02	6.8	1.47	8.4	1.76	10.3	2.09	12.5	2.44
90	5.4	1.46	8.2	2.12	10.1	2.54	12.3	3.00	15.0	3.51
110	6.6	2.17	10.0	3.14	12.3	3.78	15.1	4.49	18.3	5.24
125	7.4	2.76	11.4	4.08	14.0	4.87	17.1	5.77	20.8	6.75
140	8.3	3.46	12.7	5.08	15.7	6.11	19.2	7.25	23.3	8.47
160	9.5	4.52	14.6	6.67	17.9	7.96	21.9	9.44	26.6	11.0
180	10.7	5.71	16.4	8.42	20.1	10.1	24.6	11.9	29.9	14.0
200	11.9	7.05	18.2	10.4	22.4	12.4	27.4	14.8	33.2	17.2
225	13.4	8.93	20.5	13.1	25.2	15.8	30.8	18.6	37.4	21.8
250	14.8	11.0	22.7	16.2	27.9	19.4	34.2	23.0	41.6	27.0
280	16.6	13.7	25.4	20.3	31.3	24.3	38.3	28.9	46.5	33.8
315	18.7	17.4	28.6	25.6	35.2	30.8	43.1	36.5	52.3	42.7
355	21.1	22.1	32.2	32.5	39.7	39.1	48.5	46.3	59.0	54.3
400	23.7	28.0	36.3	41.3	44.7	49.6	54.7	58.8	66.5	68.9
450	26.7	35.4	40.9	52.3	50.3	62.7	61.5	74.4	75.2	89.41
500	29.7	43.8	45.4	64.5	55.8	77.3	67.7	92.88	83.5	110.3
560	33.2	54.8	50.8	80.8	62.5	99.7	75.8	116.5	93.5	138.3
630	37.4	69.4	57.2	102	70.3	126.16	85.3	147.38	105	174.78
710	42.1	89	64.5	130	79.3	160.2	-	-	-	-
800	47.4	113	72.6	168.9	89.3	197	-	-	-	-



## PE 100 RC MULTILAYER GAS PIPE

### PIPE TYPE 1 AND 2

<b>PIPE DESIGN</b>	BLACK PIPE WITH ORANGE - YELLOW COLOURED STRIPE OR BLACK MEDIUM PIPE WITH DIMENSIONALLY INTEGRATED ORANGE - YELLOW LAYER
<b>APPLICATION</b>	GAS PIPE FOR BURIED INSTALLATION, LAYING POSSIBLE WITH AND WITHOUT SAND BEDDING
<b>PRODUCT STANDARD</b>	EN 1555-2
<b>PROCESSING STANDARD</b>	EN 12007-2, EN 805, DIN ENV 1046
<b>MATERIAL</b>	PE 100 RC
<b>APPROVALS</b>	DVGW, MPA CERT
<b>CERTIFICATION</b>	ISO 9001/ISO 14001
<b>DIMENSIONS</b>	SDR 17; SDR 11; SDR 9; SDR 7.4; SDR 6
<b>DELIVERY FORM</b>	AVAILABLE UP TO 125mm IN COILS, DIMENSIONS FROM 140mm AND ABOVE IN STRAIGHT LENGTH

### TABLE OF PIPE DIMENSIONS

#### PE 100 RC MULTILAYER PIPE IN COILS

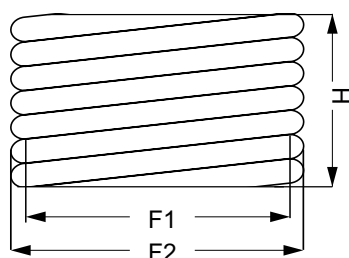
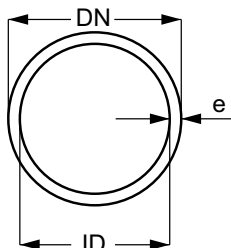

<b>SDR</b>	<b>17</b>	<b>11</b>
<b>S</b>	<b>8</b>	<b>5</b>
<b>SF</b>	<b>2.0</b>	<b>2.0</b>

<b>D (mm)</b>	<b>S (mm)</b>	<b>WEIGHT (kg/m)</b>	<b>S (mm)</b>	<b>WEIGHT (kg/m)</b>
20	2.3	0.133	3.0	0.163
25	2.3	0.171	3.0	0.212
32	2.3	0.192	3.0	0.276
40	2.4	0.296	3.7	0.431
50	3.0	0.454	4.6	0.667
63	3.8	0.722	5.8	1.50
75	4.5	1.020	6.8	1.470
90	5.4	1.460	8.2	2.130
110	6.6	2.170	10.0	3.150

## TABLE OF PIPE DIMENSIONS

### PE 100 RC MULTILAYER PIPE FOR GAS SYSTEMS

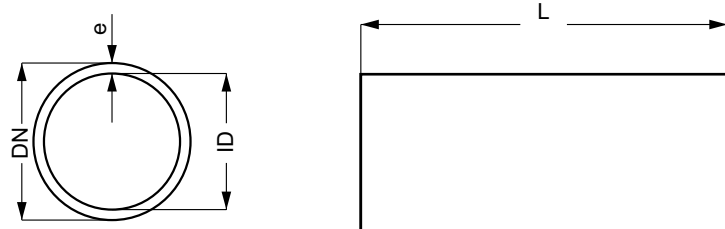

SDR	17	11
S	8	5
SF	2.0	2.0

D (mm)	S (mm)	WEIGHT (kg/m)	S (mm)	WEIGHT (kg/m)
125	7.4	2.770	11.4	4.090
140	8.3	3.470	12.7	5.090
160	9.5	4.530	14.6	6.680
180	10.7	5.730	16.4	8.440
200	11.9	7.060	18.2	10.400
225	13.4	8.950	20.5	13.200
250	14.8	11.000	22.7	16.200
280	16.6	13.800	25.4	20.300
315	18.7	17.400	28.6	25.700
355	21.1	22.200	32.2	32.600
400	23.7	28.000	36.3	41.400
450	26.7	35.500	40.9	52.300
500	29.7	43.000	45.4	64.600
560	33.2	55.000	50.8	81.000
630	37.4	69.600	57.2	103.000

## PE 100 RC + PP ADDITIONAL LAYER MULTILAYER WATER PIPE TYPE 3

### PIPE TYPE 3

<b>PIPE DESIGN</b>	BLACK MONOLAYER PE 100 RC PIPE OR BLACK/BLUE PE100RC/PE 100 PIPE WITH COLORED BLUE COLOR STRIPE +ADDITIONAL PP BLUE LAYER
<b>APPLICATION</b>	DRINKING WATER FOR BURIED INSTALLATION AND LAYING WITHOUT SAND BEDDING
<b>PRODUCT STANDARD</b>	EN 12201-2:2011, DIN 8074:2011-12, DIN 8075:2011-12, PAS 1075:2009-03-TYPE 3
<b>PROCESSING STANDARD</b>	EN 805, DIN V ENV 1046
<b>MATERIAL</b>	PE 100 RC, PE 100, PPHM
<b>APPROVALS</b>	DVGW,TZW, MPA CERT
<b>CERTIFICATION</b>	ISO 9001/ISO 14001
<b>DIMENSIONS</b>	SDR 17; SDR11; SDR9; SDR7.4; SDR6
<b>STANDRAD CLASS</b>	SDR 17;SDR 11; SDR 9; SDR 7,4; SDR 6
<b>DELIVERY FORM</b>	AVALIABLE FROM 75-125 mm IN COILS, DIMENSIONS FROM 140 mm UP TO 400 mm AND ABOVE IN STRAIGHT PIPE

## TABLE OF PIPE DIMENSIONS

### MATERIAL

INSIDE: PE 100 RC or PE 100RC / PE100,  
with outside additional PP layer

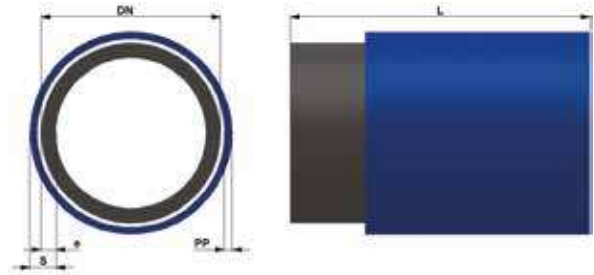

DN (mm)	SDR 17	SDR 11	SDR 9	SDR 7.4	SDR 6
	PN 10	PN 16	PN 20	PN 25	PN 32
	s (mm)	s (mm)	s (mm)	s (mm)	s (mm)
75	4,5+PP	6,8+PP	8,4+PP	10,3+PP	12,5+PP
90	5,4+ PP	8,2+PP	10,1+PP	12,3+PP	15,0+PP
110	6,6+ PP	10,0+PP	12,3+PP	15,1+PP	18,3+PP
125	7,4+ PP	11,4+PP	14,0+PP	17,1+PP	20,8+PP
140	8,3+ PP	12,7+PP	15,7+PP	19,2+PP	23,3+PP
160	9,5+ PP	14,6+PP	17,9+PP	21,9+PP	26,6+PP
180	10,7+ PP	16,4+PP	20,1+PP	24,6+PP	29,9+PP
200	11,9+ PP	18,2+PP	22,4+PP	27,4+PP	33,2+PP
225	13,4+ PP	20,5+PP	25,2+PP	30,8+PP	37,4+PP
250	14,8+ PP	22,7+PP	27,9+PP	34,2+PP	41,6+PP
280	16,6+ PP	25,4+PP	31,3+PP	38,3+PP	46,5+PP
315	18,7+ PP	28,6+PP	35,2+PP	43,1+PP	52,3+PP
355	21,1+ PP	32,2+PP	39,7+PP	48,5+PP	59,0+PP
400	23,7+ PP	36,3+PP	44,7+PP	54,7+PP	66,5+PP
450	26.7+PP	40.9+PP	50.3+PP	61.5+PP	-
500	29.7+PP	45.4+PP	55.8+PP	-	-
560	33.2+PP	50.8+PP	62.5+PP	-	-
630	37.4+PP	57.2+PP	70.3+PP	-	-

## OPTIONAL PE 100 RC MULTILAYER SEWAGE PIPE

Option-PE 100 RC multilayer sewage pipe – at the request of the customer, we can produce the PE 100 RC multilayer pipe for disposal pipelines (gravity or irrigation pipelines) in light coloured inner layer.

It allows easier camera inspection, mining application, disposal of other high abrasive media or application during water irrigation with suspended material.

All dimensions and pressure classes are available at request. Pipes can be supplied as 6 m and 12 m straight pipes or in coils of 125 mm in 100 m length.

## MARKING A PIPE

The marking of the pipes complies with ISO 4427/ EN 12201-2.

All pipes include clear, permanent marking at each meter length, made with ident printing in a colour contrasted to the pipe colour (white, black or yellow).

The following information is printed on the pipe:

- STANDARD  
e.g EN 12201-2 or DIN 8074 /PAS 1075
- Manufacturer name  
KONTI HIDROPLAST
- Nominal sizes  
(diameter x wall thickness)
- SDR serie
- Material designation  
e.g PE 100 RC /PE 100
- Pressure class  
e/g PN 10
- Production date and place
- Remaining length

Latest technologies for ident printing have been applied as well, using laser marking where a bar code having all the above information can be printed in 128 C in accordance with ISO 12176-4:2003 on the pipe.





## BARCODE LASER MARKING

### BARCODE EXAMPLES

KONTI HIDROPLAST	53102680	KONTI NUMBERS
COIL	2	PRODUCT TYPE (PIPE, COIL, PCS)
POTABLE WATER	1	PRODUCT APPLICATION
EN 12201-02:2011	01	PRODUCT STANDARD
DVGW	01	PRODUCT CERTIFICATION
SDR 17	06	SDR CLASS
Φ 63	07	DIMENSION
S = 3.8	072	WALL THICKNESS
PN 10	06	WORKING PRESSURE
PE 100	04	MATERIAL CLASIFICATION
CO - EXT	04	TYPE OF PRODUCTS (EXTRUSION, CO-EXTRUSION)
PRODUCTION LINE 4	04	NUMBER OF MACHINE
562	0182	WORKLIST NUMBER
MRS 10	2	MRS CODE
MFR 5 kg 0.2><0.35	5	MFR
BOREALIS HE3490 LS	0001	RAW MATERIAL CODE
15.03.2015	150315	PRODUCTION DATE DD/MM/Y
SHIFT NO.03	3	SHIFT

## PACKAGING

The coils are securely banded with tough tape which can be removed only by cutting.

The internal diameter of the coils is not smaller than 18 times of the nominal outside diameter of the pipe (minimum 600 mm).

## INSTALLATION

For pipe installation, it is recommended that the pipes are placed into trenches at minimal depth of 45-60 cm, depending on the freezing zone. The installation of the pipes may be performed at air temperature of  $-5^{\circ}\text{C}$ .

## METHODS OF CONNECTING

The polyethylene can be connected in different ways. The most frequent are:

- Butt welding
- Electro fusion welding
- Mechanical connecting
- 

## BUTT WELDING

The quality of butt welding directly depends on the operator's ability, the quality of the equipment and the supervisor who is responsible for the related standards. The process should be observed carefully from the beginning until the end. Before starting the butt welding process, it is important to check and verify all the parameters. Every operator should be educated and certified.

These issues should be considered before starting the welding process:

- The welding environment should be over  $+5^{\circ}\text{C}$  and, if the weather is rainy or cold, it should be done in a sheltered area;
- Pipe ends should be closed to prevent air circulation and fast cooling;
- Before starting the welding process for coiled pipes, bending must be taken away from the pipes;
- The welding zone should be clean and undamaged.



## BUTT WELDING METHOD

The principle of the butt welding system is heating the welding surfaces for a certain time and pressuring the pipes with the same inner and outer diameter. The joining area of the welding components should be cleaned thoroughly and heated up to 200°C or 220°C. Then, the components are bonded together under certain pressure.

The welding pressure, the heat and the time should be properly chosen in order not to change the chemical and mechanical properties of the welded parts.

In the butt welding method, the butt areas are pressed on the heater plate, left at zero pressure until they reach the welding temperature and joined together under pressure (welding).

If the welding is well applied, the welded zone provides the same strength as the original pipe. In order to have a good-quality welding application, the butt welding pressure, the temperature and the time parameters should be set carefully.

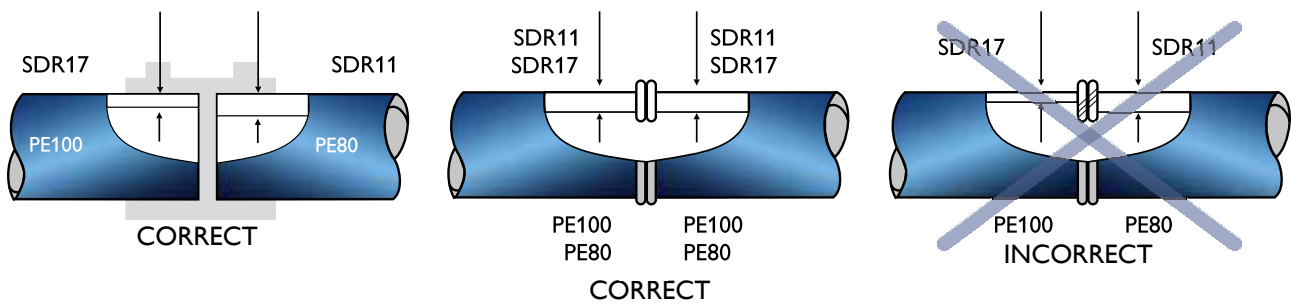

Pipes for butt welding

## BUTT WELDING PREPARATION

The temperature on the butt welding machine should be controlled just before starting the butt welding process. This must be done by an infrared thermometer. The heater plate should be left for a minimum of 10 minutes after reaching the set temperature. To insure an optimum welding quality, the heater plate has to be cleaned before every welding operation. The cleaning should be done by a soft cleaning material and alcohol. The heater plate (the Teflon coating) must be undamaged.

The joining forces and joining pressures have to conform to the machine working instructions. These can be based on the manufacturer's information or they can be calculated and measured. The moving pressure is taken from the indicators of the welding machine during the slow movement of the part to be welded. This value has to be added to the established joining pressure. The moving pressure may change depending on the machine, the pipe diameter and the pipe length. Therefore, before every welding process, the moving pressure should be read and added to the joining pressure.

The joining areas have to be planned before the butt welding. In this way, the pipes can be properly aligned and have a clean surface.

The gap width and the misalignment have to be controlled. Any misalignment must be avoided as much as possible. Even in the worst circumstances, it may not exceed 1/10 of the wall thickness.

The trimmed welding zones should not be touched and contaminated. Otherwise, trimming should be repeated. The shaving ribbons and other cut pieces must be cleared away from the welding zone without touching the trimmed faces.



## BUTT WELDING PROCESS

In the butt welding process, the welding zones are heated up to the welding temperature by the heater plate and the pipes are joined under pressure after removing the heater plate. The heating temperature should be 200°C to 220°C.

Higher temperatures are required for the thinner walls and lower temperatures for the thicker walls.

### REQUIRED TEMPERATURES FOR DIFFERENT WALL THICKNESSES

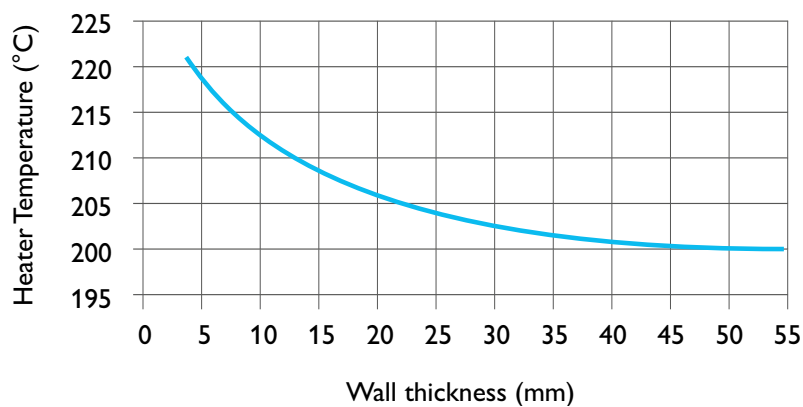

### REGIME OF HEATER PLATE SHAPED BUTT WELDING

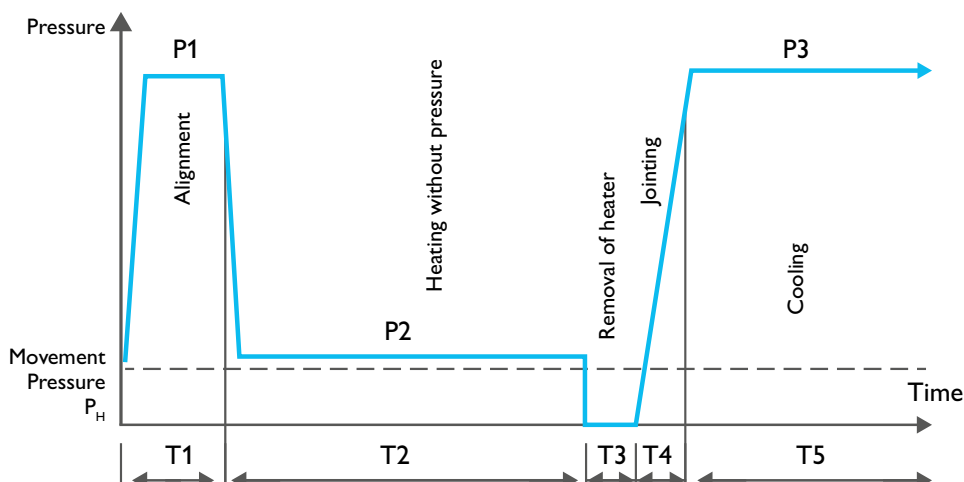

## HEATING UP WITHOUT PRESSURE

For heating up, the joining areas must contact the heater plate and the pressure must decrease. The pressure between the joining areas and the heater plate must be nearly zero ( $P_2=0.02 \text{ N/mm}^2$ ). At this time, the heat penetrates through the pipe axis. The heating up periods ( $T_2$ ) are mentioned in table 1, column 3. If a period lesser than the required is applied, the depth of the plastic part will be smaller than needed. As a result of this, the welding area will melt and corrode.

## REMOVAL OF THE HEATER PLATE

After heating up, the joining areas are to be detached from the heater plate. The heater plate should be carefully removed and the heated joining faces should be free of damage and contamination.

The joining areas should be joined together quickly after the removal of the heating tool. If the operator delays, the welding quality will be insufficient because of oxidation and cooling.

## JOINING

After the heater plate is removed, the areas are aligned closer. There must be no strike or hit during this process. The required pressure time (interfaced pressure) is obtained linearly. The required time ( $T_4$ ). The joining pressure ( $P_3$ ) is  $0,15 \pm 0,01 \text{ N/mm}^2$ .



Pipe alignment and joining, beads appear under pressure

## COOLING

The joining pressure ( $P_3$ -interfaced pressure) has to be kept during the cooling time. After the process, a regular double bead must appear. The bead size shows the regularity of the welding. Different beads could be caused by a different MFR (Melt Flow Rate) of the pipes. It must always be larger than 0.

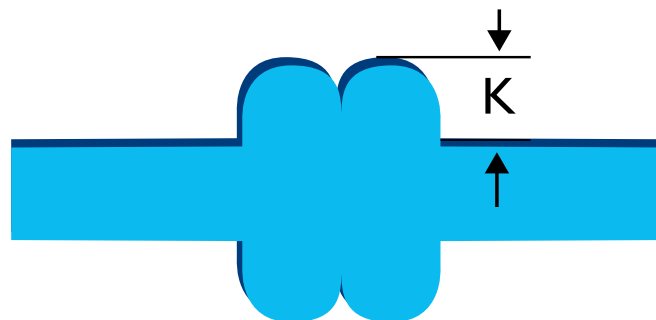

Cross section of beads

## BUTT WELDING PROBLEMS AND POSSIBLE CAUSES

BEADS ARE TOO WIDE	OVERHEATING, OVER (ALIGNING) PRESSURE
GAP LENGTH BETWEEN BEADS IS TOO LARGE	OVER JOINING PRESSURE, INSUFFICIENT HEATING
	APPLYING PRESSURE DURING HEATING
BEADS'S UPPER SIDE IS TOO STRAIGHT	OVER JOINING PRESSURE, OVER HEATING
NOT UNIFORM BEAD AROUND THE PIPE	MISALIGNING, DEFECTED HEATER PLATE
BEADS ARE TOO SMALL	INSUFFICIENT HEATING, INSUFFICIENT JOINING PRESSURE
BEADS DO NOT OVERLAP ON THE PIPE'S OUTER SURFACE	GAP HEIGHT IS LOW; INSUFFICIENT HEATING AN INSUFFICIENT JOINING PRESSURE
	GAP HEIGHT IS HIGH; INSUFFICIENT HEATING AND OVER JOINING PRESSURE
BEADS ARE TOO LARGE	OVER HEATING
BEAD OUTER EDGE IS SQUARE	PRESSURE APPLIED DURING HEATING
ROUGH BEAD SURFACE	HYDROCARBON (SOIL) CONTAMINATION

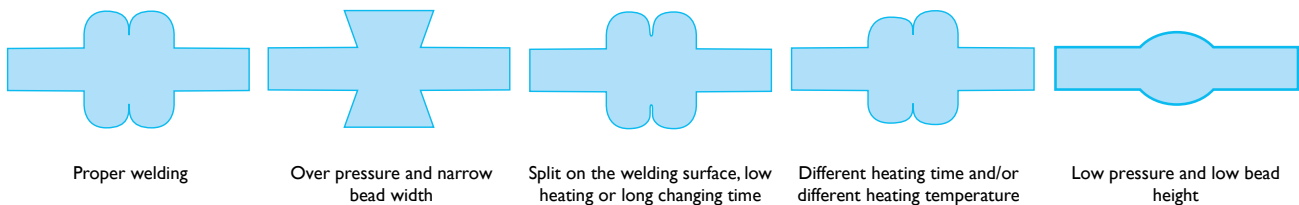

## CONNECTION METHOD FOR TYPE 3 PIPE

The connection method is the same as for the normal PE 100 or PE 100 RC pipe.

The only change is that pipe Type 3 has additional PP layer that should be peeled off without damages to the medium pipe. This is enabled with exact bonding strength that will not stick the PP layer, but will still make wear protection of medium pipe.

The butt welding preparation of Multi press PP pipe goes through the following steps:



Measure and mark the pipe



Place the cutting tool on place for cutting

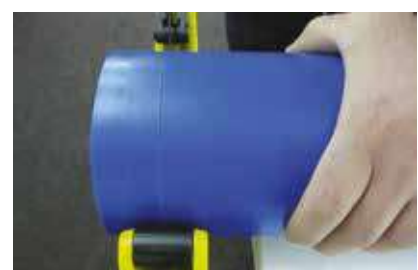

With light circular movement, cut the outside PP layer



With scalpel make a cut on circle of top layer



Pull releasable layer

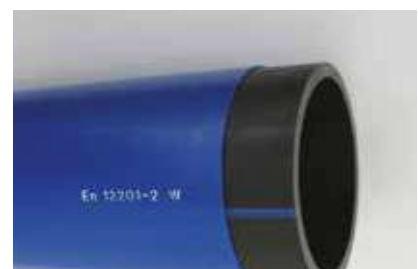

The inner layer is ready for polishing and soldering.

## CERTIFICATION

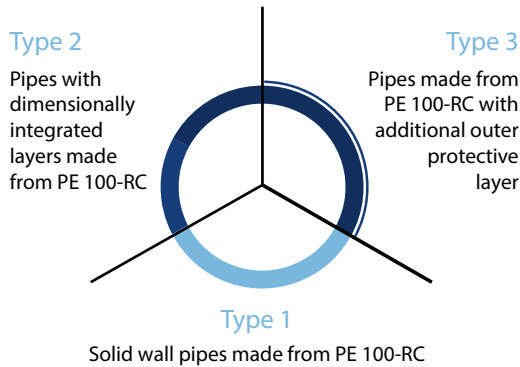

	Open method, ploughing, milling	Closed method, HDD, pipe bursting
Required component test	Point load	Score test Penetration
Type of pipe in accordance with PAS 1075	Type 1 Type 2 Type 3	Type 3

## LAYING INSTRUCTIONS

### PIPE-LAYING AND ASSEMBLY

PE 100 RC MULTILAYER pipes are laid and assembled just like typical PE 100 pipes. Due to their high resistance to point loads and surface scratching effects, the pipes can be laid in soil without backfill and sand embedding which is usually used as a protective layer for the pipes. High resistance of PE 100 RC MULTILAYER pipes to slow propagation of cracks allows pipe-laying in heavy soils with backfill and packing of crushed rocks and stones up to 60 mm of grain. Note that the soil fragments must evenly support the pipeline around its circumference. Soil transport is expensive – application of RC PE 100 RC MULTILAYER can significantly reduce the costs of supplying the construction site with proper earthwork material and the removal of excess soil from the site.

### HANDLING AND STORAGE

Before the installation of the pipes and components, check them for transport damage and other defects, and clean the joining faces and zones. Sort out damaged parts, and use a fine-toothed saw or plastic pipe cutter if the pipe needs to be cut. Cuts at right angles to the longitudinal pipe axis can be achieved when the saw is guided, for example by a mitre gauge. Once cut, prepare the pipe ends as required for the type of joining.

Unwinding pipes from bundle can be performed in various ways. In the case of pipes with outer diameter of up to 63 mm, the pipe is usually unwound with the bundle held in vertical position and the pipe fixed. The use of an unwinding device is recommended for greater dimensions.

The pipes must be unwound in a straight direction and must be kept kinked; also pulling them off in a spiral form is not allowed.

Moreover, when unwinding a pipe, it should be taken into account that the flexibility of PE pipes is influenced by the ambient temperature. At temperatures near the freezing point, pipes of an outer diameter greater than 75 mm should be warmed up before unwinding whenever possible.

Note: When shortening and laying the pipeline, remember to take the temperature-dependent length change into account. A PE pipe of 1 m length will elongate when the temperature rises and become shorter when the temperature decreases, by 0.2 mm per K.

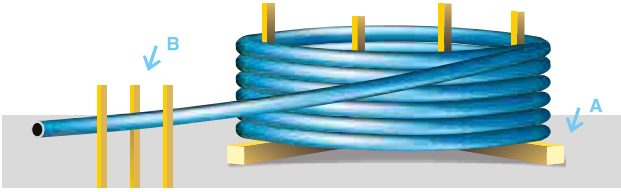

### PIPELAYING IN AN OPEN TRENCH

Applicable standards are EN 805 (water pipe), EN 1610 (waste water and sewer pipe) and EN 12207-2 (gas pipe).

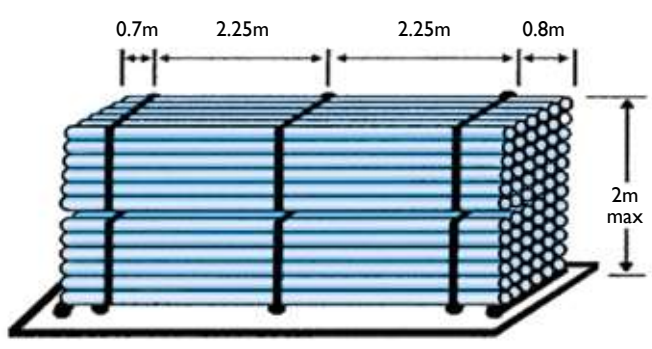
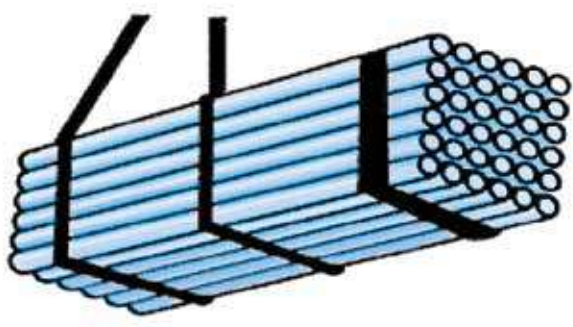
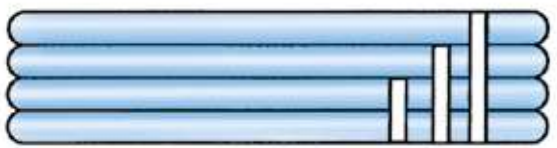
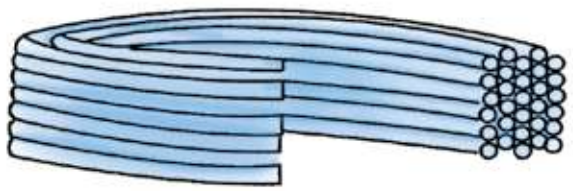

Handling and storage



## BEDDING AND BACKFILLING

Based on the proof of resistance to slow crack growth (tested by an independent subject) Multilayer PE 100-RC pipes made of PE 100-RC are suitable for laying without a sand bedding. Thus, additional work in order to replace the excavated material with a sand bed in accordance with EN 805 (transport, disposal) is not necessary. The pipe properties are such that no restriction of the grain size of the bedding and backfilling materials is necessary.

## TRENCHLESS LAYING OF PIPES

Multilayer PE 100 RC pipes are suitable for an alternative, trenchless laying.

- Ploughing
- Milling

Alternative installation methods are chosen because they are time and cost-saving. In the last few years, various installation technologies have become the state-of-the-art due to their economic advantages:

- Minimal adverse effect on developed and paved surfaces.
- Use of existing pipeline routes.
- Minor inconvenience for residents.
- Shorter construction time.
- Lower civil engineering and recultivation costs.
- Installation possible under rivers, lakes or traffic routes.
- Reduction in CO<sub>2</sub> emissions, as no vehicles are needed for transport of road surface materials, excavation work, etc.
- Avoidance of traffic rerouting and congestion.

## PLOUGHING

Ploughing is the fast and possibly most cost-effective method of laying new plastic pipes. The technique used has a minimal impact on the subsoil and is therefore considered to be environmentally friendly.

A winch is used to pull a plough blade and pipe-laying unit through the ground. Once the pipe has been installed, the furrow (trench) is automatically closed as the plough blade advances.





This method is also suitable for the parallel installation of several pipelines. As the soil initially displaced by the plough is re-used without any further processing, the pipes deployed have to be highly resistant to point, i.e. concentrated, loads. Owing to their high stress crack resistance, PE 100 RC pipes are particularly durable.

## MILLING

This laying method is usually applied in rural areas and outside traffic zones. With the milling technique, a suitable machine is used to cut a pipe trench into the soil, and the PE 100 RC pipes are simultaneously placed on the trench bottom by means of a so-called installation box. As the trench is in most cases not walkable, this box serves as a trench support in the installation of the pipeline. Once the pipe has been laid, the trench is mechanically backfilled and compacted with the previously milled-out material, i.e. no sand bed is needed.

## TRENCHLESS PIPE REPLACEMENT

- Horizontal directional drilling – HDD
- Relining
- Burst-lining

Horizontal Directional Drilling (HDD) is a method of installing underground pipelines, through trenchless methods. It involves the use of a directional drilling machine, and associated attachments. Soil is loosened and flushed out in various stages using a drilling fluid.

The first step is to create a pipe duct by means of a pilot bore. Then, in further steps the final pipe duct is widened and the pipe is introduced with the help of an insertion device.

This means very minimal surface disturbance and low reinstatement costs. We can drill under buildings, rivers, roads, through hills and rock.

## RELINING OF AN OLD WATERPIPE

Relining with pipe is a trench-free procedure, by which PE 100 RC is pulled into the existing carriage from the manhole. The individual pipes are connected with an electrical or butt welding technique.

## PIPE BURSTING

Burstlining, a trenchless pipe bursting method is used for repairing damaged pipelines by retaining or enlarging the hydraulic cross-section.

Together with the in-situ soil, the broken material compacted into the ground forms an annular space, into which the new pipeline attached to the bursting unit is introduced.

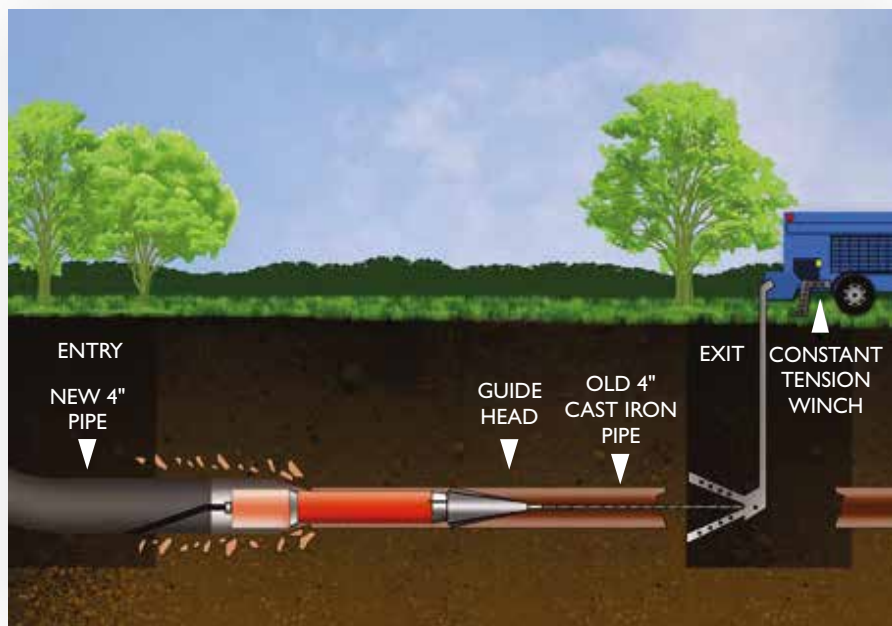

## BEDDING AND BACKFILLING

Based on the proof of resistance to slow crack growth, pipes made of PE 100-RC are suitable for laying without a sand bedding. Thus, additional work in order to replace the excavated material with a sand bed in accordance with EN 805 (transport, disposal) is not necessary. The pipe properties are such that no restriction of the grain size of the bedding and backfilling materials is necessary.

## JOINING TECHNIQUES

The standardized dimensioning for internal pressure load of PE 100 pipes is also valid for alternatively installed pipes. PE 100 RC MULTILAYER PIPE can be joined with techniques as standard PE 100 pipe, butt welding and electro fusion, as PE 100 RC is inseparable part of the pipe wall. The fittings used in this system are made of the same material as PE 100 RC.



## FITTINGS

PE 100 RC MULTILAYER PIPES provide project-related supplies and a number of special fittings upon request. For laying without a sand bedding, the latter are made of PE 100-RC. A selection is shown below – manufacturing in accordance with the customer specifications possible:

SEGMENTED BENDS

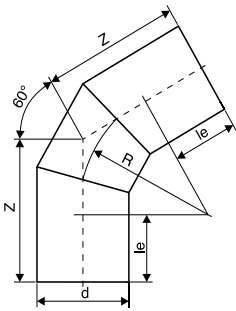
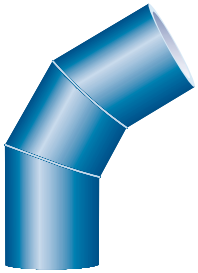

SEGMENTED T-PIECES

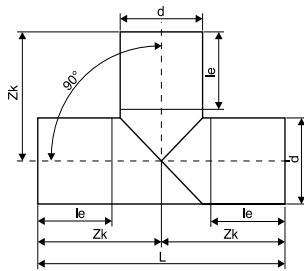
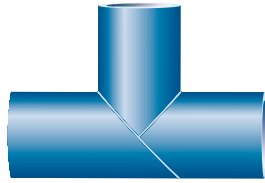

SEGMENTED DRAWN BENDS

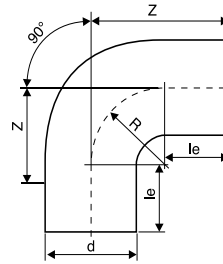

BRANCHES

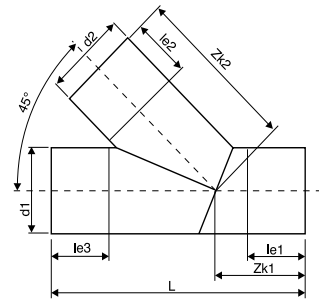
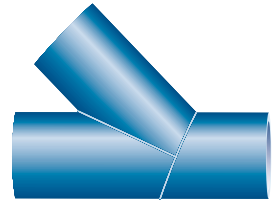

# CERTIFICATES



## LABORATORY TESTING

MELT MASS-FLOW RATE



LONGITUDINAL REVERSION



CARBON BLACK OR PIGMENT DISPERSION

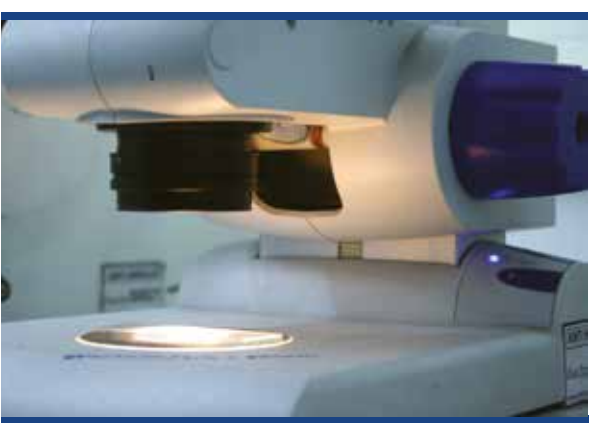

ELONGATION AT BREAK



HYDROSTATIC STRENGTH AT 80°C AND 20°C





**KONTI  
HIDROPLAST®**



NORTH MACEDONIA  
1480 Gevgelija, Industriska bb



+389 34 212 064 +389 34 215 225  
+389 34 211 757 +389 34 215 226



+389 34 211 964



contact@konti-hidroplast.com.mk  
hidroplast@t-home.mk



www.konti-hidroplast.com.mk



qualityaustria  
Succeed with Quality

EXACT



MAY, 2019